

Odosense[®]

Odor Monitoring System



About Odosense®



Odosense® is a real-time odour emission tracking solution. Odosense® continuously detects, measures and monitors the odourful gaseous contaminants. Oizom® Odour Monitoring Solution comprises of a network of e-noses (Odosense®) positioned on the periphery of the site. The solution incorporates Odour Atmospheric Dispersion Modelling for predicting odour impact on the surrounding area depending on meteorological conditions. With the help of meteorological data, Odosense® can trace the odourant dispersion plume incited by conditions like wind speed and wind direction.

Odosense® is a fully solar-powered solution with wireless data transmission. This makes it an ideal choice for landfill sites, wastewater treatment facilities, fertilizers, paper-pulp industries and soil-treatment sites, etc.



Product Features



Patented Technology

Works on innovative e-breathing technology for higher data accuracy.



Weather Resistant

IP66 Grade (certified) enclosure for endurance against harsh weather conditions.



Solar Powered with Battery Backup

Compatible to charge internal battery using solar power.



Tamper Proof

Comes with a security system to avoid tampering / malfunction / sabotage.



Retrofit Design

Plug and play design for ease of implementation.



Over-The-Air Update

Automatically upgradeable from a central server without any onsite visit.



Compact

Light-weight and compact system that can be installed at 12-15 feet (4-5 m) height.



Real-Time Data

Continuous monitoring and real-time data transfer at configurable intervals.



Ultimate Durability

Made of high-grade engineering-metal and composite polymers for a long life.



Network Agnostic

Supports a wide range of connectivity options like GSM / GPRS / WiFi / LoRa / NBIoT / Ethernet / Modbus.



Identity And Configuration

Each equipment carries its unique identity with geo-tagging through wireless configuration.



On-device Calibration

On-site device calibration capability using on-device calibration software.

Key Benefits



Robust And Rugged

Durable enclosure to sustain extreme climatic conditions.



Meteorological Capability

A provision to add Wind Direction, Wind Speed sensor for accurate source tracking of pollutants.



Multiple parameters

Compatible with a wide range of parameters including PM, gases and meteorological parameters.



Accurate Data

Gives accurate readings in real-time to detect ppb concentrations in ambient air.



Complaint Management

Users can raise complaints on the Oizom Platform for authorities to log issues and take actions.



Odour & Dispersion Modelling

Based on emissions and meteorological inputs, a dispersion model can be used to predict concentrations at selected downwind receptor locations.

Odosense® Usecases



Wastewater

Monitoring odour intensity at waste water treatment plants can help regulate odour emission by appropriate maintenance on time.



Landfills

Diffusion of odorful gases from landfills can create nuisance in the neighborhood. The odour level can be monitored to carry out precautionary steps.



Livestock

Odosense® helps operators assess the impacts of odours from their livestock operations and develop and implement the best strategies to reduce emissions and their impact.



Industries

Odourful gaseous emission from industries like agro-chemical, pharmaceutical, paper-pulp, sugar, etc. can be monitored to make data-driven measures for minimizing their fatal effect.

Odosense® Variants

Variants	Applications	Parameters
Odosense® Lite	STP, WWTP	SO ₂ , H ₂ S, NH ₃ , Temperature, Humidity, Pressure
Odosense® Smart	Solid Waste	SO ₂ , H ₂ S, NH ₃ , CH ₃ SH, TVOC, Temperature, Humidity, Pressure
Odosense® Pro	Industrial, ETP	SO ₂ , H ₂ S, NH ₃ , CH ₃ SH, TVOC, CH ₂ O, NO ₂ , Cl ₂ , Temperature, Humidity, Pressure
Odosense® Custom	As per request	Choice of upto 9 gases with External Modules.

Parameters

Sensor	ID	Range	Resolution	Min. Detection	Drift	Working Principle	Expected Sensor Life	
Sulfur Dioxide (SO ₂)	OZSO2_1*	0-10 ppm	0.001 ppm	0.01 ppm	±20 ppb / Year	Electrochemical	2 years	
	OZSO2_2	0-100 ppm	0.2 ppm	0.2 ppm	< 2% / Month			
	OZSO2_3	0-2000 ppm	5 ppm	5 ppm	< 2% / Month			
Hydrogen Sulfide (H ₂ S)	OZH2S_1*	0-1.5 ppm	0.001 ppm	0.01 ppm	±100 ppb / Year			
	OZH2S_2	0-50 ppm	0.05 ppm	0.05 ppm	< 2% / Month			
	OZH2S_3	0-200 ppm	0.2 ppm	0.2 ppm	< 2% / Month			
	OZH2S_4	0-2000 ppm	2 ppm	2 ppm	< 2% / Month			
Ammonia (NH ₃)	OZNH3_1*	0-20 ppm	0.3 ppm	0.3 ppm	< 2% / Month			
	OZNH3_2*	0-100 ppm	0.3 ppm	0.3 ppm	< 2% / Month			
	OZNH3_3	0-1000 ppm	2 ppm	2 ppm	< 2% / Month			
Methyl Mercaptan (CH ₃ SH)	OZCH3SH_1*	0-10 ppm	0.1 ppm	0.1 ppm	< 2% / Month			
Total Volatile Organic Compounds (VOC)	OZTVOC_1*	0-40 ppm	0.001 ppm	0.005 ppm	N.A.	Photo Ionization Detection (PID)	5000 Hours	
	OZTVOC_2	0-200 ppm	0.05 ppm	0.05 ppm	N.A.			
Formaldehyde (CH ₂ O)	OZCH2O_1*	0-10 ppm	0.05 ppm	0.05 ppm	< 2% / Month	Electrochemical	2 years	
	OZCH2O_2	0-50 ppm	0.1 ppm	0.1 ppm	< 2% / Month			
Nitrogen Dioxide (NO ₂)	OZNO2_1*	0-10 ppm	0.001 ppm	0.01 ppm	±20 ppb / Year			
	OZNO2_2	0-100 ppm	0.2 ppm	0.2 ppm	< 2% / Month			
	OZNO2_3	0-500 ppm	0.5 ppm	0.5 ppm	< 2% / Month			
Chlorine (Cl ₂)	OZCl2_1*	0-20 ppm	0.05 ppm	0.05 ppm	< 2% / Month			
	OZCl2_2	0 - 50 ppm	0.1 ppm	0.1 ppm	< 2% / Month			
Methane (CH ₄)	OZCH4_1	500-1500 ppm	1 ppm	500 ppm	N.A.			Molecular Property Spectrometer (MPS)
	OZCH4_2	50-10,00,000 ppm	1 ppm	50 ppm	N.A.			
Hydrogen Chloride (HCl)	OZHCl_1	0-50 ppm	0.5 ppm	0.5 ppm	< 2% / Month			Electrochemical
	OZHCl_2	0-100 ppm	1 ppm	1 ppm	< 2% / Month			
Ambient Noise	OZN_1*	Upto 140 dB	1 dB	0.5 dB	N.A.	Capacitive		
Temperature	OZTEMP_1*	-40 to 125°C	0.01°C	-40 °C	N.A.	Solid State Semiconductor Sensing		
Humidity	OZHUM_1*	100% Rh	0.1%	0.1%	N.A.			
Barometric Pressure	OZPRES_1*	300-1100 hPa	0.18 Pa	300 hPa	N.A.			

External Modules



Anemometer
OZWSD_1*

Wind Speed: 0-40 m/s
Wind Direction: 0-359°
Working Principle: Ultrasonic



Rain Gauge
OZRAIN_1*

Resolution: 0.25 mm
Working Principle: Tipping Bucket

*Indicates standard delivery timeline.

Specifications

Mechanical

Size	360mm (H) x 328mm (W) x 200mm (D)
Weight	7.2 Kg (instrument weight)
Material	Aluminum Magnesium Alloy, Mild-steel (With Powder Coating), FRP
Certifications	CE, FCC, NEMA 4X, IP66, RoHS

Electrical

Avg. Power Consumption	5 Watt (Actual consumption depends upon the number of parameters)
Power Input Options	AC : External 110-240V AC, 50-60Hz DC : Uninterrupted 24V DC, 2 Ampere 60 Watt 24V Solar Panel
SMPS Specs	24V, 2Amps output UL-62368 & CAN/CSA C22.2 Certified
Battery Backup Time	Upto 12 Hours
Battery Specs	Lithium iron phosphate (LiFePO4) battery cell with rated voltage 12.8V Capacity 6Ah

Technical

Processor	Quad Core ARM Cortex
Memory	2GB RAM / 8GB eMMC ROM
Device Interface	On-device Software / API / Cloud Platform
Internal Data Storage	Upto 8 GB or 90 days

Environmental

Operating Temperature	-20 °C to 60 °C
Operating Humidity	0-93% RH
Recommended Humidity	15-90% RH
Storage Conditions	10 - 40°C







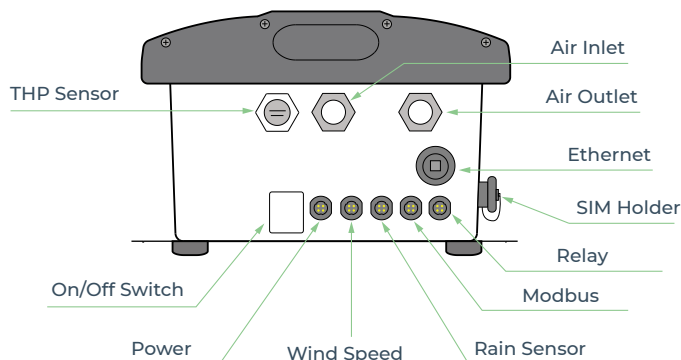

Sensing

Gas Measurement Principle	Active Sampling with Sampling rate of 325 mL/Sample
Warm up time	< 48 hours for data stabilisation

Communication

Data Interval	2-30 (configurable) minutes
Data-push Protocol	HTTP post request to host server
Data-pull	HTTP request on device IP
Firmware Updates	Over-The-Air Firmware Update
Standby Connectivity	GSM (2G/3G/4G) for remote diagnosis, FOTA updates, and cloud calibration
Certification	PTCRB, CE, FCC, RoHS, ICASA, GCF



Connectivity Options		Specification
Wireless	 GSM	Global 2G / 3G / 4G
	 LoRa	868 MHz / 915 MHz
	 LTE	CAT-M1
	 NB-IoT	CAT-NB1
	 sigfox	868 to 869 MHz, 902 to 928 MHz
	 Wi-Fi	AP Mode and Station Mode
Wired	 ETHERNET	Static / DHCP Configuration
	 Modbus	RS485 RTU / TCP
	 RELAY	2 Channel Relay

Functional Specifications

Proper location selection is critical for optimized data collection. It varies as per the purpose of the project. According to USEPA QA handbook (Vol II, Section 6.0 Rev.1), the selection of locations should be based on monitoring purposes.

Preferred Mounting	Pole / Wall (preferably 270° open surrounding)
Installation Height	12-15 feet (4-5 meters)
Direction	As per maximum direct sunlight exposure
Power Availability	Constant AC / DC supply within a 2-meter range from the unit or solar panel
Network Availability	Uninterrupted network connection

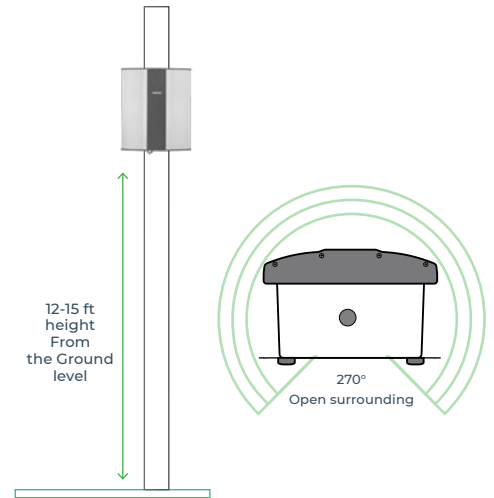

Data and Calibration

1 Laboratory Calibration

All air quality monitoring systems are calibrated at the ISO/IEC 17025:2017 certified calibration laboratory using standard NIST traceable calibration gas standards as per the international guidelines by USEPA.



2 Collocation Calibration

The monitors are operated adjacent to a custom built reference station housing U.S. EPA designated Federal Equivalent Method (FEM) for collocation calibration to ensure optimum data quality.



3 On-site Calibration

On-site calibration of Oizom® devices can be performed using standard calibration gas cylinders of known concentration or by co-locating with a reference standard.



Solution Architecture

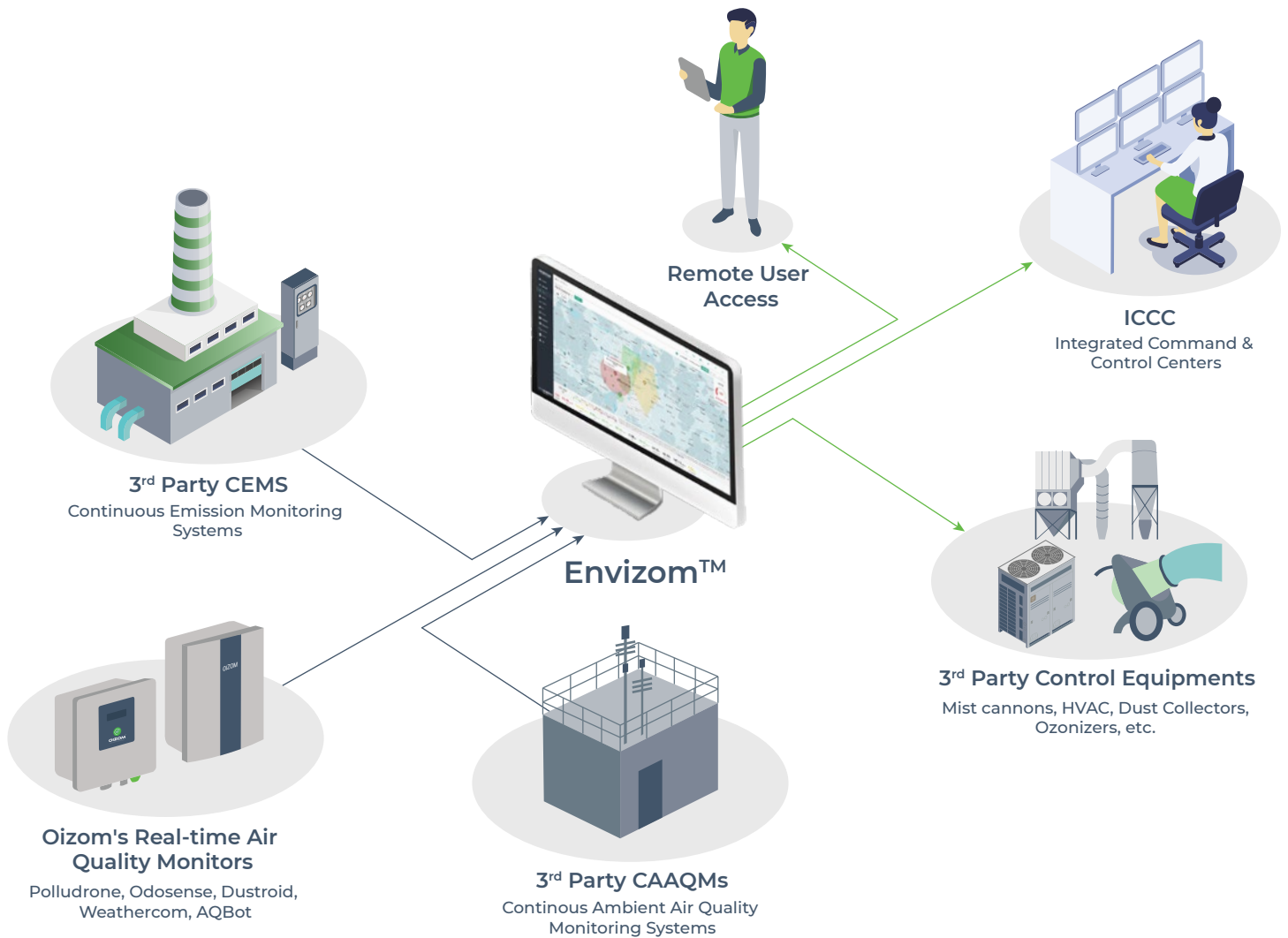

Envizom™ Air Quality Software

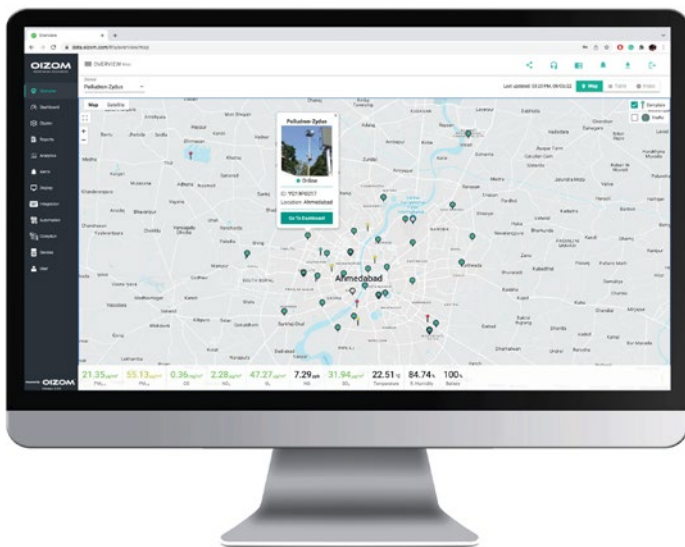

An on-device data software enables users to access the data, configure networks and sensors without any dependency on the internet. Users can also connect their smart devices to Odosense® and view real-time data, perform on-site calibration, change network configuration, and change sensor configuration.

Envizom™ Features

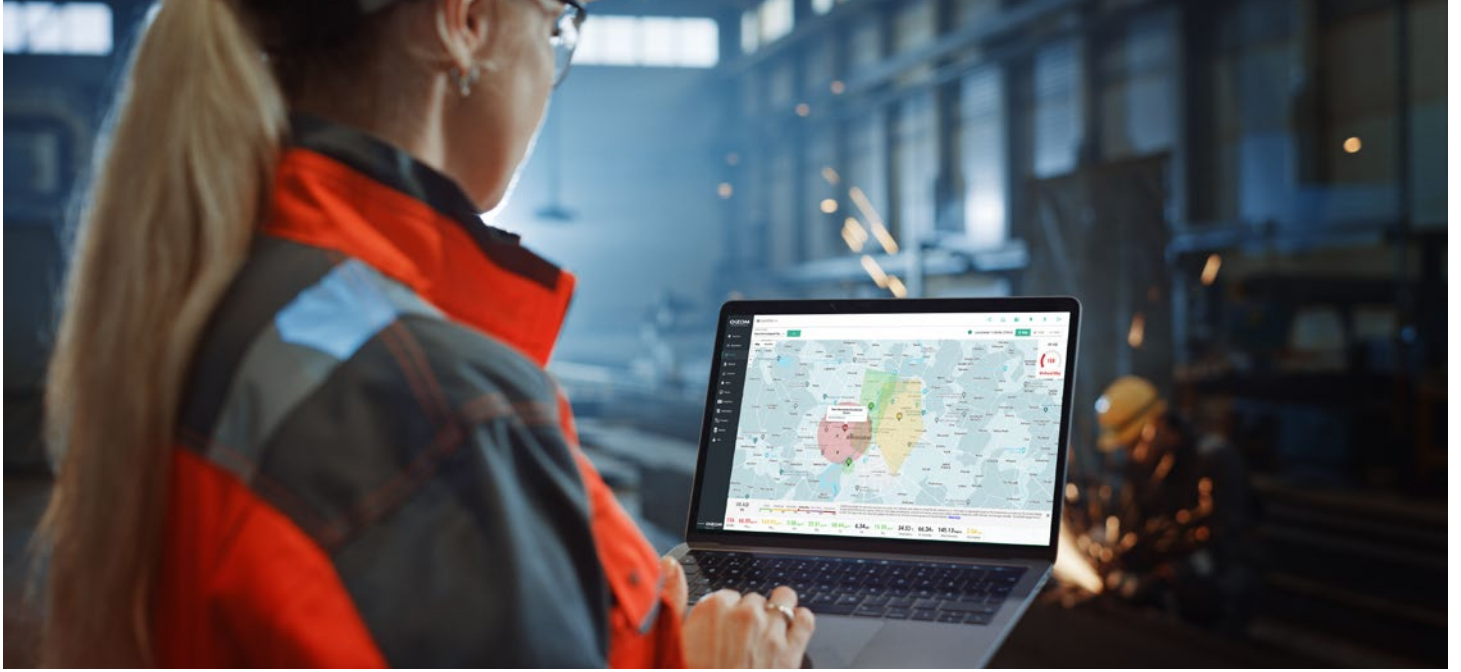

Real-time data



Smart alerts



User friendly interface



Easy to Set Up



One click share



Data accessibility

Privacy First Platform



Data Privacy

The data shared with the client uses an encryption server through HTTPS Secure Socket layers. Envizom™ also uses AES encryption for connection that adds to data safety.



Data Ownership

Envizom™ creates a secured and encrypted password combination for the user login. Oizom® ensures 100% privacy of the data and doesn't share without relevant permissions.



Data Transparency

Data collected from Oizom® equipment runs through the Environment Data Interpretation Engine. It processes various algorithms and eliminates environmental impact interferences on the sensors.

Case Studies



Monitoring hazardous gas levels at an Oil refinery in Tehran

Oizom® provided Odosense to the Department of Environment of Iran. It helped the authorities to get a real-time read on the harmful gaseous levels in the Behran Oil Company's Oil refinery, Tehran.



Iran



December 2021



Industrial
Odour

Monitoring odour and air quality in Masan Group, Vietnam

Oizom®'s Odosense® is monitoring odour and air quality in Masan Group, Vietnam to ensure hygienic standards of environment for workers.



Vietnam



October 2021



Industrial
Odour



Bioreactor Landfill odour monitoring in Republic of Croatia

A Bioreactor Landfill in Croatia installed Oizom®'s odour monitoring system, Odosense® Smart to monitor odour and other air pollutants.



Croatia



March 2022



Industrial
Odour

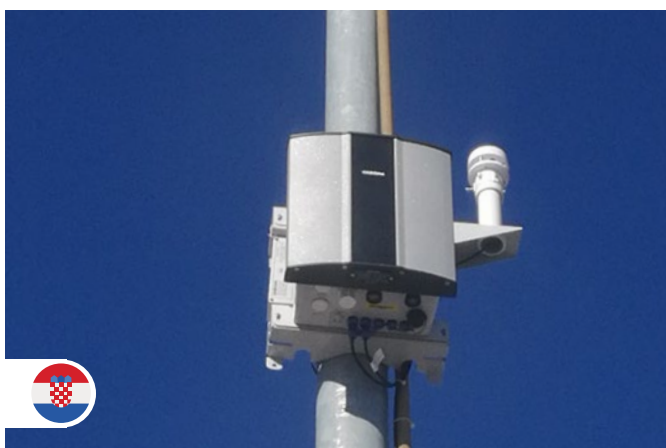

Case Studies



H₂S monitoring at Sanford Waste Water Treatment Plant

Oizom®'s odour monitoring solution with real-time data visualization was deployed at Sanford Wastewater Treatment Plant to monitor Hydrogen Sulfide.



USA



June 2020



Industrial
Odour

Monitoring odour levels in Dubai's Waste Water Treatment Plant

Oizom®'s Odosense® and Weathercom® are monitoring the air quality and odour levels in Dubai's Waste Water Treatment Plant.



Dubai



February
2022



Industrial
Odour



STP Odour Monitoring in Palava City

Through Oizom® Odor Monitor Odosense®, the inconvenience from STP odour dispersion in the Palava Campus was reduced significantly by suppressing the odour.



India



September
2017



Industrial
Odour

About Oizom®



Leaders in sensor based
air quality monitoring



Plug and play monitors
for hassle free setup



Low powered solutions
for multiple applications

Oizom® is an environmental IoT company offering data-driven environmental solutions for better decision-making. With our sensor-based hardware, we monitor various environmental parameters like air quality, noise, odour, radiation, weather conditions, etc. Our data analytics platform derives many actionable insights for authorities, communities, and industries. Oizom® strives to play an essential role in a sustainable future through smart environmental solutions and data science.

Oizom® has years of experience in stimulating innovation by creating groundbreaking technology for environmental monitoring. With an IoT-based development approach, Oizom® has been able to successfully unlock multiple solutions, catering to various industries.

Other Oizom® Products



Polludrone®

Ambient Air Quality Monitoring

Polludrone® is ideal for real-time ambient air quality monitoring for urban and industrial applications.



Dustroid®

Real-time Dust Monitor

Dustroid® is an online particulate monitoring system to measure a wide spectrum of particulate matter sizes.

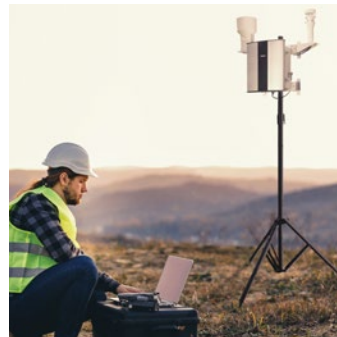

Weathercom®

Automatic Weather Station

Weathercom® is an automatic weather station designed to measure various meteorological parameters.



AQBot™

Single Parameter Air Quality Monitor

AQBot™ is an industrial grade single parameter air quality monitor with automation capabilities.





Trusted by

60+ Countries



Solutions Installed in

65+ Cities



Total Devices Installed

1000+



Total Population Covered

200 million+

Global Presence



Accurate Air Quality Monitoring And Advanced Data Analytics



Get in touch



306, Indraprasth Corporate,
Prahlanagar, Ahmedabad - India

✉ contact@oizom.com / connect@oizom.com

☎ +91 88666 60025 / 39